

Flowing shapes in stainless steel

Stainless steel tubes and components worldwide

fischer know-how impresses in every market

The fischer group is one of the world's leading suppliers of tubes and components made of stainless steel, titanium, and top-quality special alloys. In eight countries, the fischer group produces using machines, tools and manufacturing processes developed in Germany.

No matter where our customers are, fischer stainless steel tubes and components are delivered to them as quickly as possible. With uniform fischer quality worldwide.



The fischer group produces stainless steel tubes and components all over the world, using processes, machines, and tools developed in-house in Germany.

The fischer group and its international sites

We have produced stainless steel tubes and components for over 50 years. Ideas, courage, responsibility, and commitment have made us one of the strongest partners in this market. Around 2,800 employees annually process over 123,000 tons of steel into more than 158 million meters of tubes.



"For me, it has always been part of our concept that we only produce top-class quality. This attitude is honored by our customers throughout the world."

Hans Fischer,
company founder and Managing Partner,
fischer group

fischer Edelstahlrohre

Production of longitudinally welded tubes made of stainless steel, titanium, and nickel-base alloys

fischer Rohrtechnik

Further processing of tubes into components and assemblies

fischer Hydroforming

Development and manufacture of complex hydroformed components

fischer Maschinentchnik

Development of machines and tools for tube production and further processing



Our active corporate philosophy

First-class quality, above and beyond the norm

We have always had the goal of combining first-class quality with maximum customer satisfaction. This is only possible because we implement and continuously develop the entire process – from the slit strip to the complex components – completely within the fischer group.

At our international locations, we produce high-quality longitudinally welded tubes and process them into precisely manufactured complex components. We also develop the required technology ourselves and work out customized product and service solutions for our customers. All of this is based on actively practiced values and clear standards that make us a reliable production and development partner.



“Long-lasting success only comes from constant improvements. The fischer group is a strong engine for continuing to promote the exceptional possibilities of stainless steel tubes.”

Hans-Peter Fischer, Managing Director, fischer group

Responsibility for the people in and outside the company

It is the people that are behind the results. The fischer group cultivates cooperation and responsibility oriented company culture – from the production to the management. This results in motivated and loyal employees who carry out our company philosophy – for the benefit of our customers.

Market-leading capabilities

For decades, fischer has been known for the quality of its manufacturing and processing of welded stainless steel tubes. In particular, we are actively advancing the precise manufacturing of thin walled tubing.

Full-range supplier

The fischer group offers an entire range of services relating to stainless steel tubes and components: virtually all material grades, shapes, wall thicknesses and diameters, as well as many different forms of further processing, even into complex structural shapes.

Prototypes and tailored solutions

Our high production competence makes us the contact for the realization of your ideas. From prototypes to individual solutions to series production. We have developed feasible solutions for many shapes that seemed impossible.

Service and logistics

We are always thinking and acting in the best interests of our customers. Our services thus fit as harmoniously as possible into their chain of value creation. First-class service, from product development to customized delivery, for us goes without saying.

Continuous improvement

We are constantly working on the optimization of internal and external processes and the improvement of our products.

Our experience for your benefit

The fischer group offers excellent know-how and services over the complete horizontal chain of value.

This pays off for the customer in many ways:

- ▶ *From development, tube manufacturing, and further processing to the finished component – everything from a single source*
- ▶ *A solid contact for your requirements*
- ▶ *Quick “time to market”*

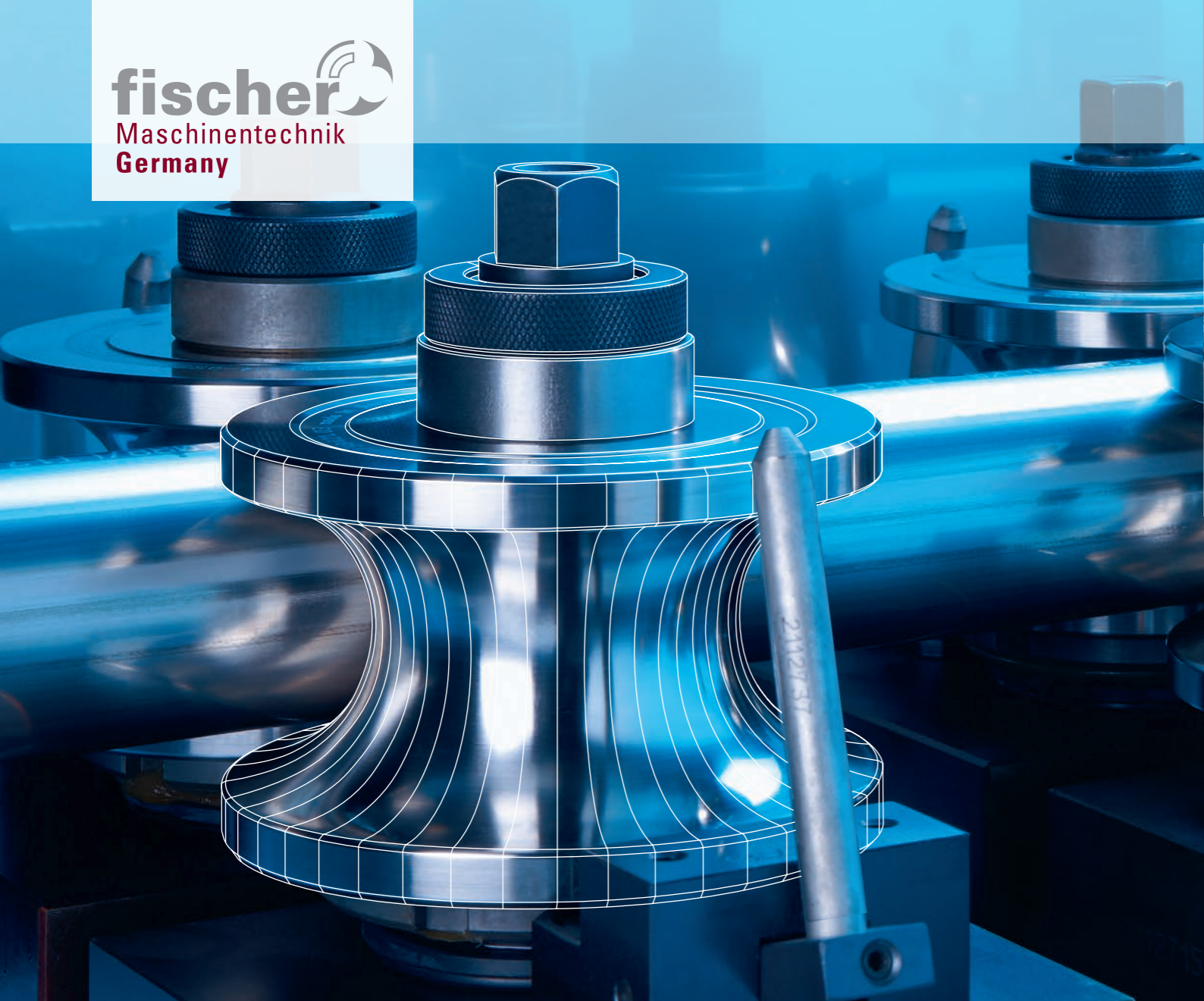

"Here in Achern we have the best conditions for continuing to advance processes and technologies for tube manufacturing and processing. What we have gathered here in specialized knowledge and experience is unique in the world."

Roland Fischer, CEO,
fischer Maschinentechnik GmbH

Key facts about fischer Maschinentechnik

- ▶ **Exclusive in-house development for exceptional results**
- ▶ **From designing to manufacturing machines, systems, and tools**
- ▶ **Developments with the latest CAD software**
- ▶ **Continuous improvement of processes and products in collaboration with the fischer group's production companies**
- ▶ **Part of the quality management system and certified according to ISO/TS 16949:2009, ISO 9001:2008 and VDA 6.1**
- ▶ **Based in Achern, Baden-Württemberg, Germany**

Ensured international transfer of know-how

Machine technology within the fischer group

The best results take place when everything comes from within a concerted effort and is fully developed right down to the smallest detail. That is why it has always gone without saying within the fischer group, that all procedures and equipment are developed, improved and modified within the group. This responsibility falls to fischer Maschinentechnik GmbH. In clearly defined processes, it ensures a uniform machine technology at all our production locations world-wide. The transfer of know-how is guaranteed by the continuous international exchange of information within the fischer group. You can be sure that the same processes and quality standards are implemented everywhere where fischer is represented around the world.

Our achievements within the fischer group



Tube machines and tools



Special facilities, automation, control technology and software



Hydroforming tools



Materials

The materials processed by fischer Edelstahlrohre cover a wide range of requirements for desired properties such as corrosion or heat resistance:

- ◻ Austenite
- ◻ Ferrite
- ◻ Super ferrite
- ◻ Duplex
- ◻ Super duplex
- ◻ Nickel-based
- ◻ Titanium

Speciality: thin-walled tubes

One main focus of fischer's production of stainless steel tubes are thin-walled tubes with a small wall thickness to diameter ratio.



Expertise in tubes

Welded fischer stainless steel tubes for the world's industries

More and more areas of application are emerging for welded tubes made from stainless steel and other alloys in world-leading fischer quality. Applications range from use in the automobile, chemical, and food industries to supplying energy and the household sector. This also reflects our variety and flexibility.

At fischer, the material, wall thickness, diameter, and length are customized and produced precisely to your requirements.



fischer relies on laser welding

The fischer group is one of the pioneers in laser welding in tube manufacturing. As a result, we have years of experience and we know this specialized field, inside and out.

- ◻ Laser welding with a weld seam factor of $V = 1.0$
- ◻ Suited for extreme deformations and loads
- ◻ Safe due to high quality standards

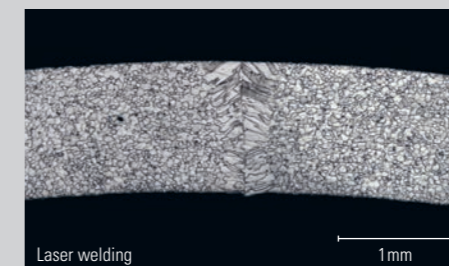

Tube expertise in all sectors

Customer-oriented solutions

The special qualities of stainless steel – its rigidity and resistance to corrosion even at consistently high temperatures – have made stainless steel tubes and components the preferred component parts in many fields of industry.

The fischer group is winning over customers in more and more industries with its extraordinary focus on the customer and solutions. We manufacture exactly the tubes that you need for your tasks: from stainless steel or other high-quality materials and alloys. We work precisely according to your requirements.

Talk to us about your plans and ideas. We will provide you with options – flowing shapes and complex components made of stainless steel or other high-quality alloys.



fischer stainless steel tubes in the automotive industry

From exhaust manifold components to tail pipes – fischer stainless steel tubes ensure reliable mobility.



Tubes and profiles



Exhaust gas cooling tubes



Endless tubes



Exhaust manifold components



Catalytic converter and filter shells



Tail pipes

fischer stainless steel tubes in pipe construction

Fischer tubes offer the required reliability wherever foodstuffs or aggressive chemicals are supposed to flow safely.



fischer stainless steel tubes in the energy industry

Whether in cooling towers, solar thermal systems, or power plants – fischer tubes ensure long-term optimal heat exchange.



fischer stainless steel tubes in process equipment

Thin-walled tubes in particular are ideally suited for heat exchangers in a wide variety of applications – even at high temperatures.



"I am fascinated again and again by how great the variety of industries and applications there is for fischer stainless steel tubes – from supplying energy to household appliances, from long tubes to complex components – we deliver impressive products anywhere."

**Manfred Seewald,
Head of Sales Industry & Trade**



Above and beyond the standard

Special shapes are our strength

The standard fischer range already covers a wide variety of tubular components. Aside from these, fischer can further demonstrate their competence by applying their processing know-how to develop solutions for your particular application.

Ask us. We would be happy to engineer a solution to your problem.



Plenty of made-to-measure sizes

All shapes and sizes are possible within these ranges:

Dimensions

External diameter:	6 to 206.0mm
Wall thickness:	from 0.1mm
Tube length:	up to 36m (straight tube) or up to 15m (U-shaped tube)
	Endless manufacture on coils: up to 3,000m (longer is also possible, depending on the wall thickness)
Thin-walled tubes (e.g.):	6 x 0.1mm 16 x 0.2mm 50 x 0.2mm 70 x 0.8mm 100 x 1.0mm 160 x 1.0mm
Fixed lengths:	from > 5mm

Shapes

- ▶ Round tubes
- ▶ Square tubes
- ▶ Rectangular tubes
- ▶ Profile tubes
- ▶ Special geometries

Thin-walled tubes

fischer specializes in thin-walled tubes with a small wall thickness to diameter ratio. Thin-walled tubes are used in heat exchangers, for example.



Profile tubes, special shapes

fischer can make tubes in virtually any shape desired, upon request. We would even be happy to tackle unusual geometries for you.



Tubes from endless manufacture

fischer Edelstahlrohre provides tubes from endless manufacture in coils for producing rods or supports.



Perforated tubes

Perforated tubes are used in filter technology and in sound insulation. fischer supplies the permeable tubes with the desired arrangement of holes and the suitable profile.

Annealed tubes

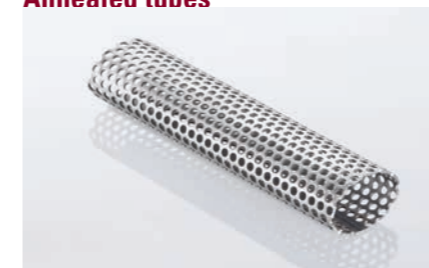

fischer provides annealed tubes for demanding applications in chemical plant construction.



Tubes with mechanically treated surface

We put the finishing touches on the surfaces of your tubes – up to 600 grit.



Cut to length

Alternative separating technologies are available for cutting the tubes to the required length. Laser cutting and contour cutting are precise and offer minimal loss of material. Normal sawing can also be combined as needed with deburring and washing.



Talk to us about your ideas.

We will certainly be able to find a solution for you too – beyond the standard.

First-class results in mass production

Our quality standards and how we test them

After roll forming and welding, fischer stainless steel tubes are inspected for the specified characteristics. Every heat lot undergoes extensive quality checks. We do everything so every tube from our plants meets the fischer groups's high standards.

That is why you can always rely on the flawless quality of fischer tubes.

Keywords: Quality and qualification

Only qualified employees can produce quality. That is why continuing and advanced training of the employees plays an important role at fischer.

By means of internal exchange and external support we ensure that everyone is as well-equipped as possible for their task and does not lose sight of the big picture. This is how we can promise consistent quality work.

Certifications

The fischer group is fundamentally oriented to the highest quality standards. This has been confirmed in numerous industry-specific and cross-industry certifications. We meet the specifications of the International Automotive Task Force (IATF) and work according to certified assurance systems in accordance with ISO/TS 16949:2009 and ISO 9001:2008, EN 764-5 section 4.2 and AD 2000 leaflet W0. fischer is counted among the welding

companies approved by Germanischer Lloyd and bears the IGR seal of the chemical industry as a cooperation partner. We manufacture in accordance with the European Pressure Equipment Directive 97/23/EG and the norms of the American Society for Testing and Materials (ASTM) and the American Society of Mechanical Engineers (ASME).



ISO/TS 16949:2009 | ID:0910170483



ISO 9001:2008 | ID:0910170483



WZ 520 HH 4

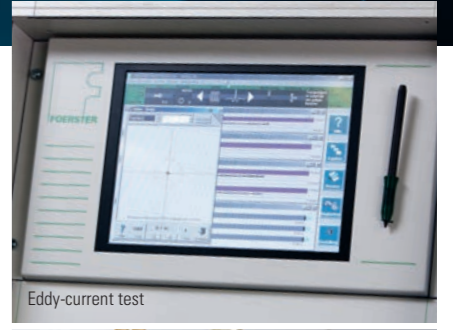

Quality checks

Non-destructive tests

- ▶ Air under water
- ▶ Eddy-current
- ▶ Ultrasound
- ▶ Dimensional inspection and dimension measurement
- ▶ Surface test (roughness)

Corrosion tests

- ▶ Intercrystalline corrosion test
- ▶ Test for corrosion-producing residues
- ▶ G48 test

Destructive tests

- ▶ Chemical analysis/spectral analysis
- ▶ Tensile test
- ▶ Cone test
- ▶ Ring flattening test
- ▶ Ring tensile test
- ▶ Re-bend test
- ▶ Flanging test
- ▶ Dye penetrant test
- ▶ Hardness test
- ▶ Burst testing
- ▶ Metallographic test

Residual dirt analysis under cleanroom conditions

For many customers, the analysis under cleanroom conditions is a must. We therefore have installed a unit for testing the technical cleanliness of functionally relevant automobile parts and components for fluid systems in accordance with VDA 19 and ISO 16232. With this unit, we can test every lot immediately on site.





Individual components from the prototype to the full-production run

Highly-qualified employees, the most modern engineering hardware and software, certified processes and plenty of experience ensure that we bring your requirements swiftly from the prototype to mass production, in line with the demands of the market.

An overview of the production

processes

The fischer group offers all standard tube processing technologies to satisfy customers inquiries. We can thus satisfy almost any requirement.

- ◊ Axial forming
- ◊ Bending
- ◊ Hydroforming (IHU)
- ◊ Soldering and welding (TIG, MAG, resistance welding)
- ◊ Mechanical cold forming
- ◊ Metal bellows technology
- ◊ Stamping, coping, punching, flaring/necking, cutting
- ◊ Cleaning and surface treatment
- ◊ Tube end shaping
- ◊ Sawing, laser cutting
- ◊ Chipless cutting technology
- ◊ Joining/assembly technology
- ◊ Heat treatment
- ◊ ...

Our development services

- ◊ Automation technology, component development
- ◊ Component development/ tool construction
- ◊ Analysis of weld geometry/ metallography
- ◊ Material analysis/ corrosion analysis
- ◊ Finite element analysis
- ◊ Product and process engineering
- ◊ R&D/ engineering
- ◊ Rapid prototyping (3D printing)
- ◊ ...

An astonishing variety of shapes

Using fischer Rohrtechnik for increasingly complex shapes

Your requirements for tube components made from stainless steel or other alloys are not standing still. The choice of material and the technology are continuing to develop. With innovative processes, fischer group specialists can thus continually make the tubes into new shapes.

Lighter, more complex, more sophisticated – to fit your demands.



Exhaust system as an installation example for fischer Rohrtechnik products

Further processing tubes

Reliable processes for forming technology

The variety of fischer tubes carries over into the variety of the types of processing. These disciplines of further processing within the fischer group will help you to speed up your processes and improve your competitive situation.

We would like to work side by side with you throughout the whole process.



Bending



We bend tubes up to a diameter of 80mm for use as automobile exhaust pipes or charge air pipes, as well as fluid lines, grab bars, and brackets.

Calibration and final processing



Tube ends can be processed by us axially or radially, as well as chamfered, deburred, flared, or cut to fit. Typical applications are welded or v-band joints in gas-tight pipe systems.

Stamping and punching



We further process tubes by stamping and punching, for example, components for domestic water supplies and heating installations.

Soldering



By means of tube end shaping, we join tubes together or calibrate them – also with an air gap, depending on the requirement. The tube thus reduces the heat losses in the exhaust system and optimizes the acoustics.

3D laser cutting and inscribing



We also make complex 3D laser cut contours, produced on 5-axis machining centers without combustion residues, cutting splatter, and material discoloration (inert gas atmosphere). Applications for these are resonators, tail pipes for exhaust systems, and jacket tubes for particle filters and catalytic converters.

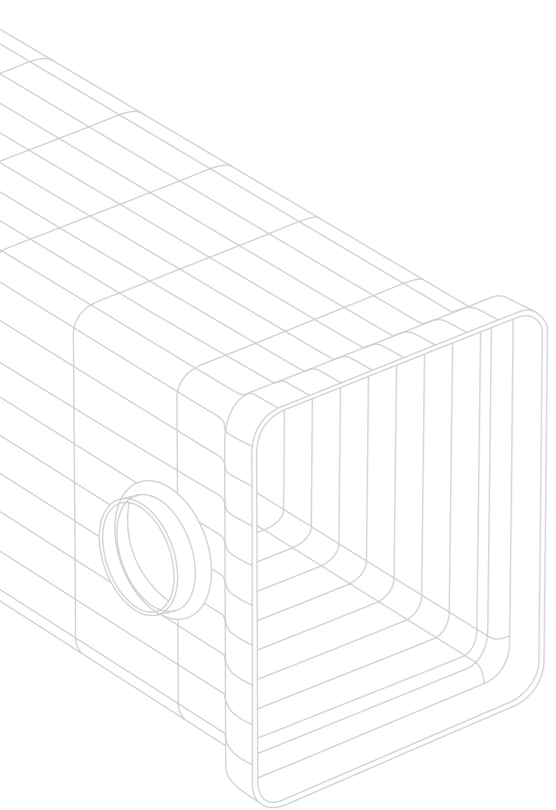

From semi-finished parts to complex components

Have your assemblies manufactured by the fischer group

We devote the same meticulousness and dedication to putting together complex assemblies as with manufacturing and further processing tubes. Step by step, we develop the optimal production process and implement it for you. In doing so, the production specialists of fischer Rohrtechnik work closely together with the fischer Maschinentechnik's development professionals. This results in customized processes for complex components that combine the best fischer quality with cost efficiency.

Talk to us about your plans for complex components.

We will be happy to present you with the best solution.

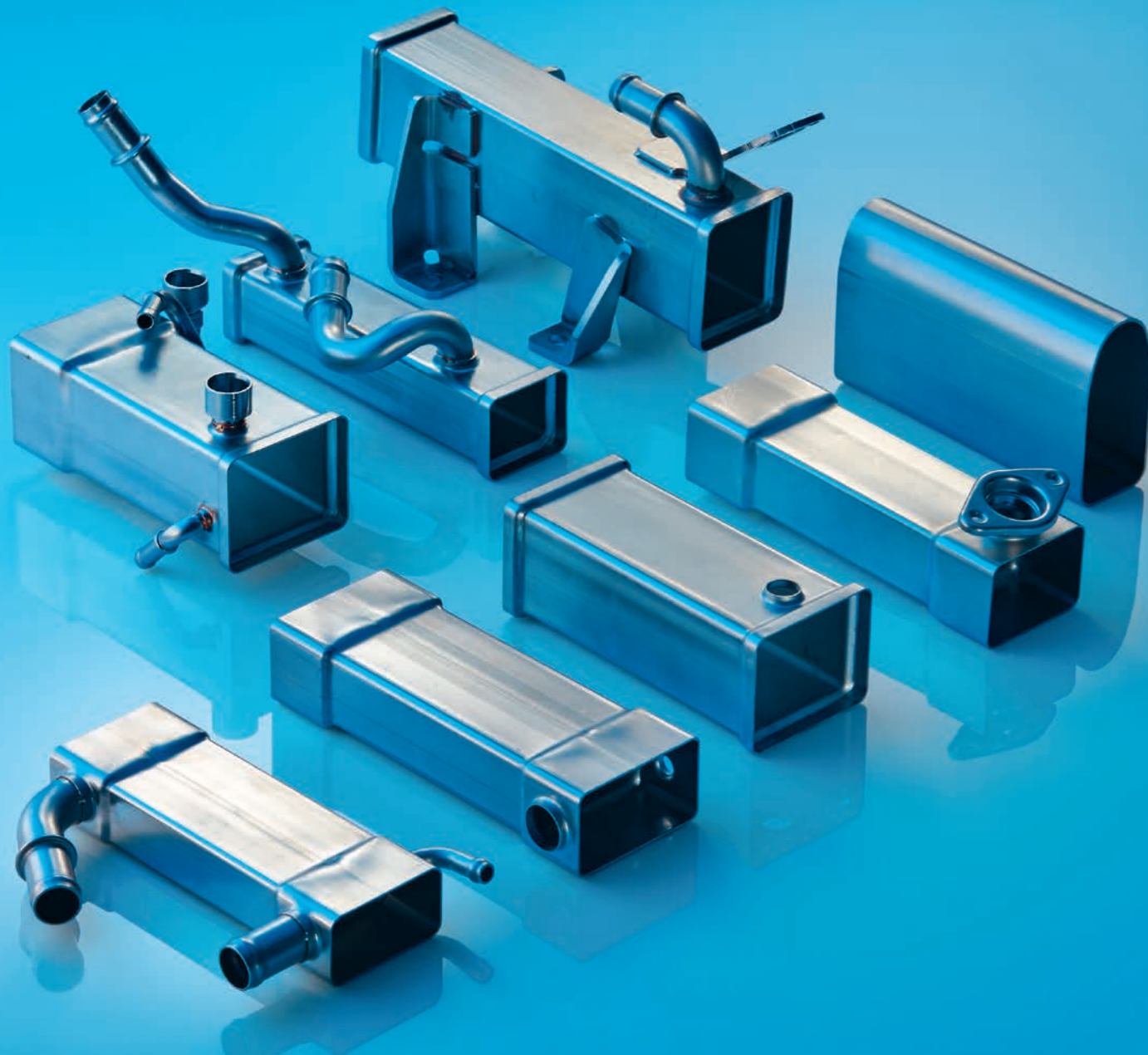

Housings



We manufacture complex housings, for example, exhaust gas cooler housings with all connections and mounts.

Shells



Double-walled and air-gap shells for exhaust particle filters or catalytic converters are joined, calibrated, welded radially, and tested for leaks.

Customized solutions



Customized development can be implemented according to your requirements for everything from fuel distributors to tube parts for tank filling and ventilation in the automobile industry to completely manufactured telescopic tubes for vacuum cleaners in the industrial and household sectors.

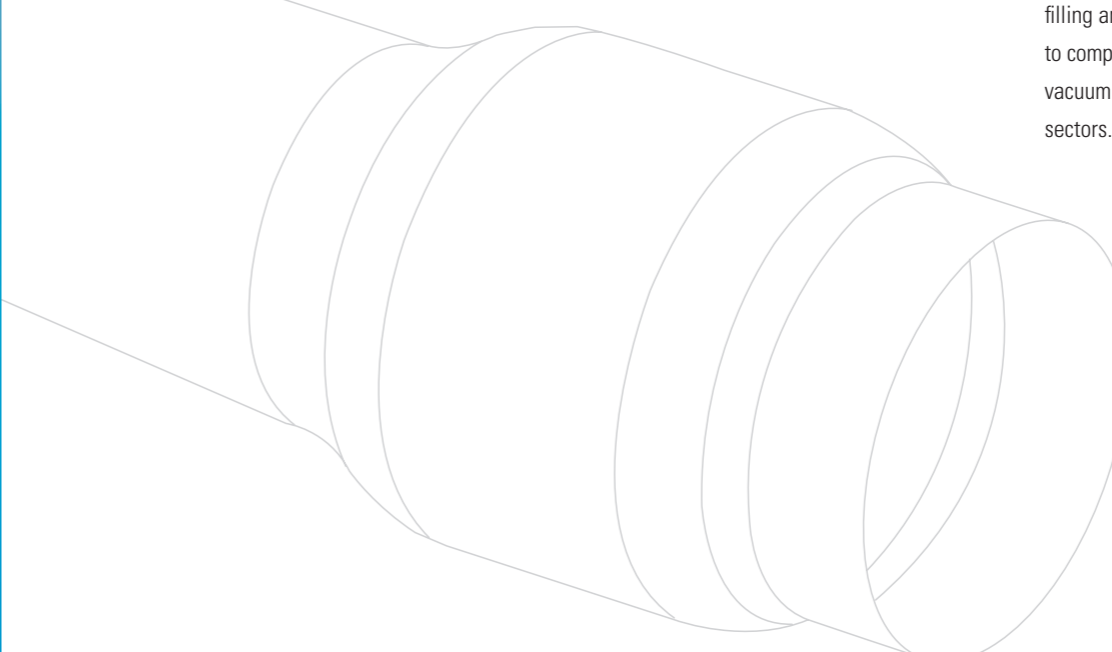



Boundless shapes – formed by the power of water

fischer Hydroforming – innovative solutions for complex forming

The development of hydroforming has significantly expanded the possibilities for forming tubes or sheet metal particularly of stainless steel. With a great deal of experience, we can create boundless forms in countless series applications, which would not be possible with conventional production methods.

Break new ground – with fischer Hydroforming

The basic principle behind hydroforming

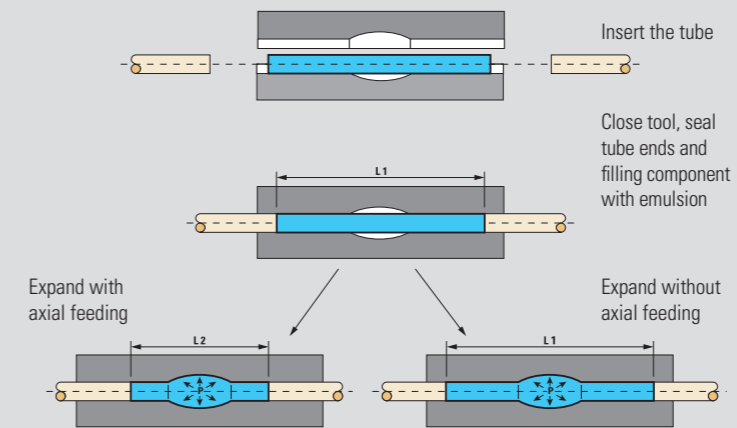

During hydroforming, tubes or other hollow sections are expanded by means of high pressure of up to 3,000 bar (43,511 psi) in a form tool. Multiple work stages can thereby be combined or joining operations avoided.

World leader in multi-stage forming



fischer Hydroforming has established in-house all the process steps for the multi-stage forming of components. An economical and quality-assured application of the hydroforming process is thus available for the most complex customer requirements. Based on the know-how of fischer Hydroforming Germany, this applies not only to the German locations but to the various international sites as well. With hydroforming, the fischer group has achieved a leading market position, particularly from a global perspective.

Due to the continuous ongoing development of the process and the discernible variety of advantages, it increasingly pays off nowadays to rely on hydroforming for smaller unit numbers as well. Whatever the application: pipelines, exhaust manifolds, construction elements in machine building, structural parts for automobiles, and housings with complex inflow and outflow components or design features.

How you can take advantage of the technical and business advantages of hydroforming:

- ▶ *Complex, 3-dimensional geometries and cross-sectional and perimeter enhancements in a few process steps*
- ▶ *Costs are reduced by*
 - ▶ *Savings in materials due to the use of thin-walled tubes (reduction in wall thickness, weight and installation space as compared to cast or bending parts with the same or higher static strength)*
 - ▶ *The ability to replace several work steps (joining, soldering, welding, milling) with only one hydroforming component*
- ▶ *High degree of measurement and form precision*
- ▶ *High degree of repeat accuracy of the forms*
- ▶ *Multiple parts in one hydroforming tool ensure multiple uses*
- ▶ *Elimination of subsequent operations due to geometry flexibility*
- ▶ *Standardization of components across the entire product range*

Hydroforming esteemed across all industries

More and more possibilities through exceptional forming technology

Hydroforming has established itself in many industries – from designer telephones, heating and solar technology, equipment and apparatus industry to the aerospace industry. However the core market continues to be in the area of automobile applications – both for passenger cars as well as commercial vehicles.

The key products range from numerous components in the exhaust system – from the manifold to the tail pipe – to heat exchanger tubes and other connections to supporting structures in the construction of the chassis.



The path to your hydroformed component

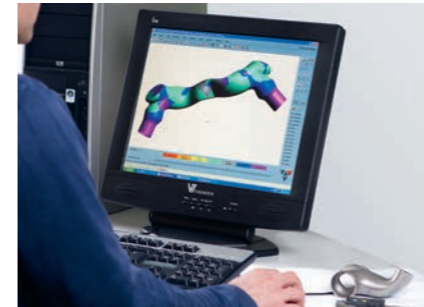

Our specialists can accompany you from idea to series production, whether as component, assembly or multi-part assembly (ZSB). We focus on feasibility, quality and profitability at each step of the process. Since we manage the entire development and production process within fischer group, we always maintain full

control of the process. So you can be sure: fischer Hydroforming turns the positive results of a feasibility analysis and FEM simulation into reality. Exactly as you require, within a contractually guaranteed timeframe and budget.

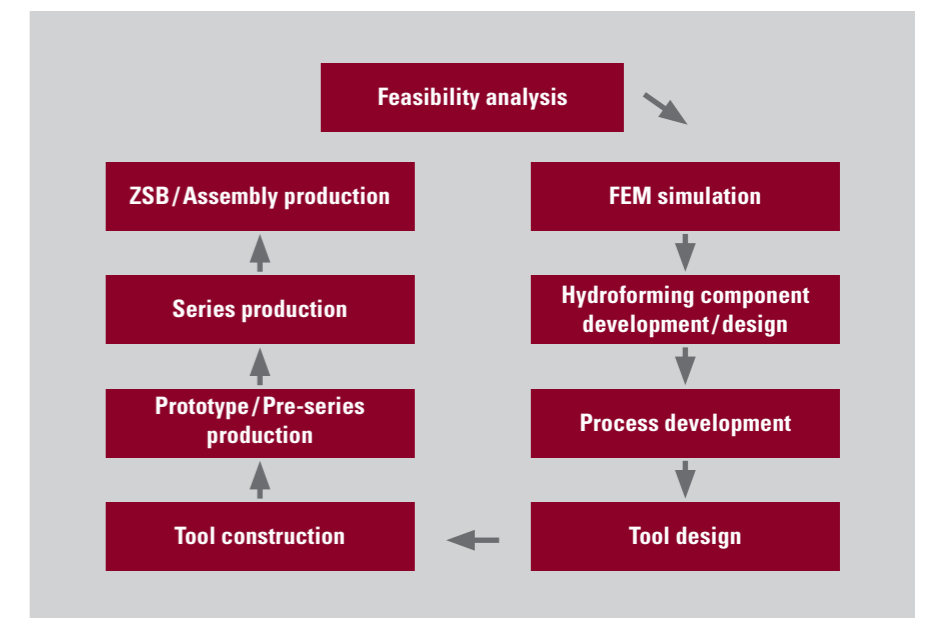

"Hydroforming offers the optimal combination of shape diversity, function and materials savings in connection with maximum stability and precision."

Dr. Stefan Geißler,
CEO, fischer Hydroforming GmbH,
Menden/Chemnitz





The advantage of working together

fischer group – your global contact for tubes and complex stainless steel parts, special alloys, or titanium.

There is more to international competition than the bottom line. Above all, consistent quality, high flexibility and versatility and exceptional problem-solving ability play important roles in a fast-moving global market. There are long-term benefits from efficient creation and production regardless of the industry.

The fischer group is your global first contact for developing and producing welded tubes and the corresponding complex components made of stainless steel, special alloys, or titanium. All fischer companies possess these effective and ultimately necessary qualities.

Together we can achieve a lot.

Which challenge do you want to tackle next?

How fischer group customers benefit

- ▶ **Global representation:**
wherever you need us, we are nearby.
- ▶ **A wealth of experience:**
from the development to the production of a wide range of tubing and complex components.
- ▶ **Exceptional quality:**
fischer is known for around the world.
- ▶ **High degree of flexibility:**
everything according to your requirements.
- ▶ **Speed:**
extremely fast turn-around, if and when required.
- ▶ **Innovation:**
if something does not yet exist, we will develop it for you.
- ▶ **Focus on service:**
we deliver components preassembled to your machine or installation site. Anywhere in the world.

Your Direct Line to the fischer group

- ▶ Phone +49 7841 6803-0
- ▶ Fax +49 7841-22530
- ▶ sales@fischer-group.com
- ▶ www.fischer-group.com

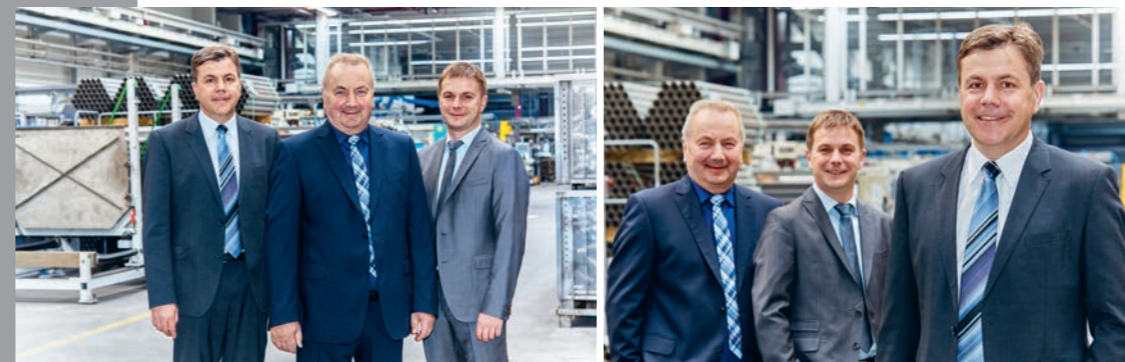

"We always offer you optimal solutions for your requirements. And you can rely on this: we commit to what we offer. That's a promise."

Hans-Peter Fischer,
Managing Director,
fischer group



The companies of the fischer group develop and manufacture tubes and complex components made of stainless steel, special alloys, or titanium. The fischer group has its headquarters in Achern, Baden-Württemberg, Germany, and subsidiaries in Canada, South Africa, Mexico, the United States, Austria, China, and Uruguay.



Im Gewerbegebiet 7
D-77855 Achern-Fautenbach
Phone +49 7841 6803-0
Fax +49 7841 22530
sales@fischer-group.com



www.fischer-group.com